

Siemens PLM Software

NX Advanced Simulation

Integrating FE modeling and simulation streamlines product development process

Benefits

- Speed simulation processes by up to 70 percent
- Perform accurate, reliable structural analysis with integrated NX Nastran solver
- Increase product quality by rapidly simulating design tradeoff studies
- Lower overall product development costs by reducing costly, late design change orders
- Efficiently manage large, complex analysis models
- Capture and automate best practices and commonly used processes
- Easily add multidiscipline simulation capabilities as your analysis needs grow

A modern CAE environment

NX™ Advanced Simulation software is a modern, multidiscipline computer-aided engineering (CAE) environment for advanced analysts, workgroups and designers that need to deliver high-quality performance insights in a timely fashion to drive product decisions. NX Advanced Simulation integrates best-in-class analysis modeling with the power of an integrated NX Nastran® desktop solver for basic structural analysis. NX Advanced Simulation also forms the foundation on which you can perform additional solutions for advanced structural, thermal, flow, engineering optimization and multiphysics analyses, all in a single environment.

Providing finite element modeling for experienced CAE analysts

Using NX Advanced Simulation drastically reduces the time you spend preparing simulation models. NX delivers all the advanced meshing, boundary conditions and solver interfaces that experienced analysts expect for high-end analysis. However, what makes NX Advanced Simulation

unique from all other finite element (FE) preprocessors is its superior geometry foundation that enables intuitive geometry editing and analysis model associativity to multi-computer-aided design (CAD) data. The tight integration of a powerful geometry engine with robust analysis modeling commands is the key to reducing modeling time by up to 70 percent compared to traditional FE modeling tools.

Enabling fast, intuitive geometry editing

NX Advanced Simulation is built on the same leading geometry foundation that powers NX. By using NX Advanced Simulation, you can rapidly clean up and prepare geometry from any CAD source through direct modeling. Geometry edits and the complete analysis model remain associated to the base design, which means you can easily update your analysis model each time the design changes. As a result, the NX CAE geometry editor accelerates your design-analysis iterations and improves your overall productivity.

NX Advanced Simulation

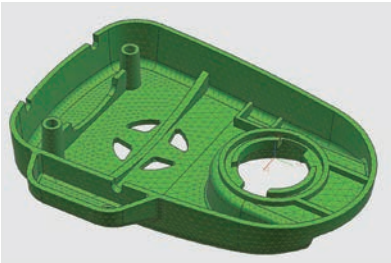

Shown is an initial analysis model.

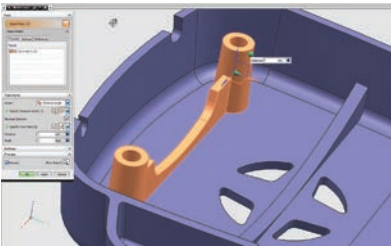

Use synchronous technology and select geometry to move interactively.

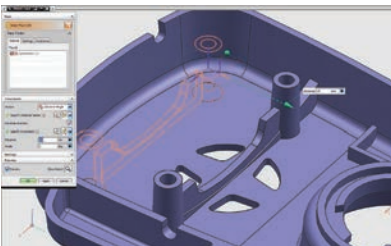

Simply drag geometry to a new position.

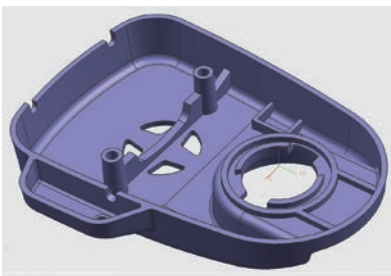

New design ready to be analyzed.

Direct geometry editing with synchronous technology NX Advanced Simulation includes direct geometry editing capabilities powered by synchronous technology, combining the flexibility of direct modeling with the best of dimension- and constraint-driven techniques to provide you with the most control. Analysts can quickly edit geometry in intuitive ways that are not possible in traditional CAE preprocessors or feature-based CAD systems. Direct editing will work on geometry from any source, and analysts can use it to rapidly de-feature or modify geometry prior to meshing, create design alternatives for what-if evaluations, or rapidly generate fluid domain volume geometry.

In addition to synchronous technology, NX Advanced Simulation delivers a wide range of geometry editing capabilities that are needed to de-feature, abstract and idealize geometry for CAE purposes, such as:

- Geometry healing and repair for gaps and other data inaccuracies
- Mid-surfacing to create surfaces for thin walled components
- De-features tools (geometry repair, feature suppression, stitch surface, remove hole/fillet and partitioning)
- Non-manifold topology generation for volumes
- Creating a surface from an orphan mesh
- Split body and partitioning methods for dividing solid geometry into more manageable sections prior to hex meshing

Rapid design-analysis iterations through associativity User-defined geometry edits, FE mesh and boundary conditions are all associated to the base design. When the design topology changes, NX rapidly updates the existing analysis geometry, mesh, loads and boundary conditions as required, avoiding the need for the analyst to manually recreate the analysis model. This approach greatly reduces downstream modeling time, which is compounded across a project's many design-analysis iterations.

Multi-CAD support NX Advanced Simulation supports CAD geometry from a number of formats, and all NX Advanced Simulation direct editing and idealization capabilities can be used on geometry from all of these formats:

- Direct geometry translators available (CATIA V4, CATIA V5, Pro/E)
- Neutral geometry transfer (IGES, STEP, JT™, Parasolid®)

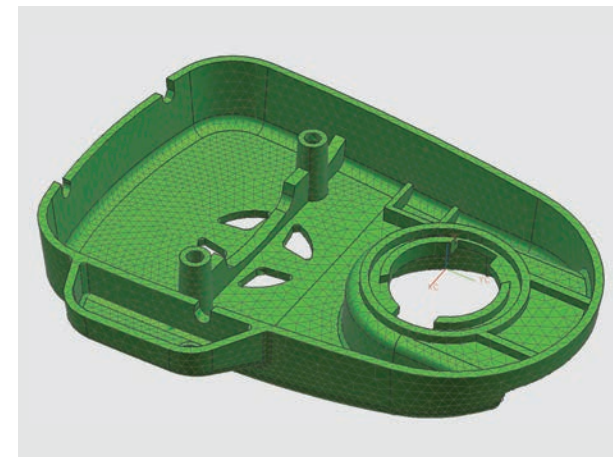

Associated mesh updates in a matter of seconds and is ready for immediate analysis.

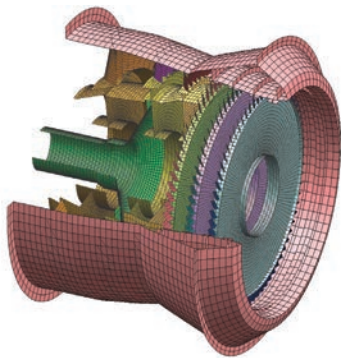

Extensive meshing tools are available for thin-walled parts.

Delivering comprehensive meshing

NX Advanced Simulation includes extensive modeling functions for automatic and manual mesh generation of 0D, 1D, 2D and 3D elements, and also numerous techniques for the application of loads and boundary conditions. As mentioned previously, the mesh and boundary conditions are all associated to the geometry to allow you to rapidly update your analysis model when there is a design change. This can save you hours, days or weeks of work depending on the complexity of your model.

0D and 1D meshing You can create 1D elements, such as welds, bolts, rigids and beams and other elements with ease. NX Advanced Simulation can be used to leverage CAD information to help you quickly create beam section properties and facilitate the creation of FE weld connections based on the weld data contained in the CAD assembly.

2D shell meshing NX Advanced Simulation provides a number of tools to help you create accurate FE meshes needed for thin-walled components. These tools can be used in conjunction with mid-surface, and the types of 2D meshing methods include:

- Mapped meshing to control the distribution of elements across a surface
- Free (unstructured) meshing for surfaces with more than four sides
- Dependent meshes to ensure meshes match in contact or symmetric regions

3D solid meshing Thick, chunky components are often modeled using tetrahedral or hexahedral elements. NX Advanced Simulation offers the necessary tools to quickly create solid elements, including:

- Automatic best-in-class tetrahedral meshing
- Swept hexahedral meshing
- Pyramid elements needed to smoothly transition from a hex mesh to a tetrahedral mesh

Mesh control and editing In addition to creating meshes, NX Advanced Simulation helps you fine tune and edit meshes to achieve quality criteria and achieve more accurate results. Capabilities include:

- Mesh morphing to modify existing meshes to match new geometry dimensions
- 2D and 3D mesh controls for fillets and cylinders
- Extensive mesh quality checks and reporting
- Local element control for precise mesh generation
- Batch meshing with mesh controls for use in automated processes

Flexibly apply loads and boundary conditions

The geometry engine at the core of NX Advanced Simulation provides you with the flexibility to apply loads and boundary conditions either to geometry features or directly to the FE mesh, depending on your needs. Load and boundary conditions can be applied in the following manner:

- On geometry (face, edge or curve) to maintain associativity when design geometry changes
- On FE entities (nodes, elements, element faces and element edges), which is useful when working with imported meshes with no underlying geometry
- To local coordinate system
- To groups for easier management
- As axisymmetric boundary conditions for simplifying the study of revolved systems
- As loads automatically obtained from motion analysis in NX Motion
- As time-varying condition sequences for simulating mission profiles
- As defined by expression, array or table input

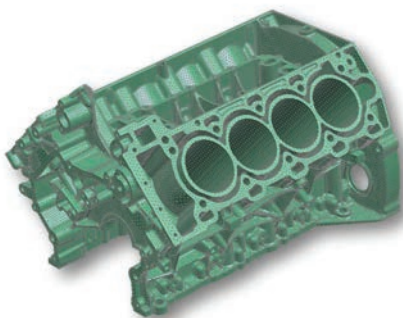

Quickly mesh complex geometry with automatic best-in-class tetrahedral meshing.

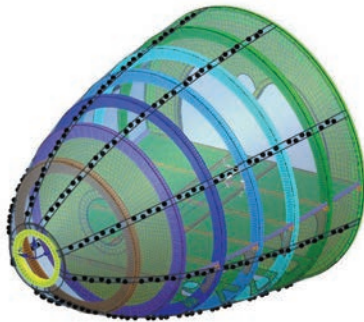

Easily build, connect and manage large FE assembly models.

Facilitating efficient FE assembly management

NX Advanced Simulation is unique in the way it creates FE assembly models. Unlike traditional CAE preprocessors that were developed for component analysis and require you to build monolithic analysis models, NX Advanced Simulation's assembly FE model (AFEM) management tool creates large FE assembly models by instancing and connecting FE component models together, similar to a CAD assembly. When an FE component is updated later in development, NX Advanced Simulation updates all instances of that component within the FE assembly, eliminating the need to rebuild and connect a new FE assembly together.

Simulate with embedded structural analysis

NX Advanced Simulation includes the NX Nastran Environment and an integrated NX™ Nastran® – Basic desktop solver. NX Nastran – Basic provides access to a broad library of finite element types and material models, robust manipulation of load cases, along with several efficient solution sequences for linear statics, buckling and normal modes analyses on models of unlimited size. A heat transfer capability provides solutions to steady-state and transient thermal analysis and design problems. A basic nonlinear capability enables including large deformation and material nonlinear effects in the solution.

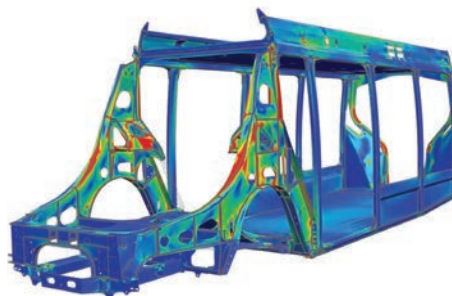

NX Nastran – Basic is integrated in NX Advanced Simulation for a complete structural analysis solution.

The NX Nastran – Desktop Advanced bundle and/or individual modules for NX Nastran can also be added to NX Advanced Simulation to extend structural analysis capabilities.

Preprocess with multi-CAE environments

NX Advanced Simulation can be used as the primary pre- and postprocessor for Siemens PLM Solvers, NX Nastran and LMS Samcef, or for a number of third party solvers, such as Abaqus, ANSYS, LS-DYNA, and MSC Nastran.

This is accomplished through immersive user environments that use the selected solver's terminology, which enables analysts to easily prepare solver-specific analysis models without the need to learn new terminology.

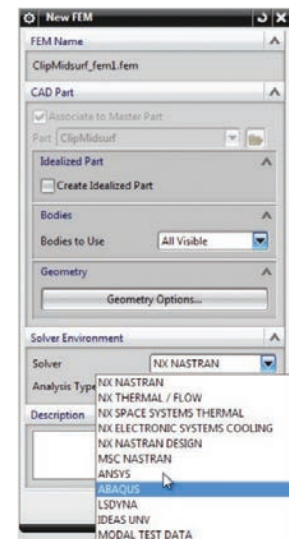

Preprocess analysis models for external solvers.

Postprocess results and create reports

For analysis to drive decisions, results must be presented in an understandable form. NX Advanced Simulation provides extensive graphics and manipulation capabilities that focus on critical data and present it for review and action. Additionally, the multi-CAE environments for Nastran, Abaqus, Ansys and LS-Dyna can import result files created by these solvers for easier postprocessing and reporting.

Results displays NX Advanced Simulation includes various ways you can control the display of simulation results, such as deformation, contour plots, isosurfaces, streamlines, animation and text annotations.

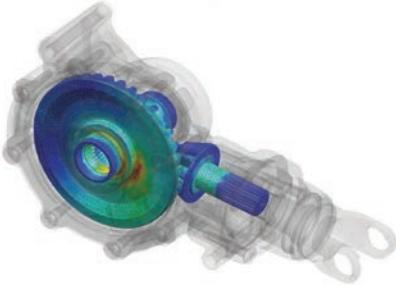

Robust postprocessing capabilities for graphics, results probing, graphing and reporting.

XY Graphing Graphing can be critical to understanding how results change over time or at various locations of your model, and NX Advanced Simulation delivers extensive XY graphing capabilities from basic scatter plots to plots for complex results. Of course, NX Advanced Simulation also gives you full control over the appearance of your graphs for reporting purposes.

Reporting and export With no more than a few mouse clicks, you can easily create and assemble simulation reports inside NX Advanced Simulation. Simulation reports can be customized to include boundary conditions, material properties, images and graphs, and can be easily exported for sharing with external audiences.

Providing a platform for multidiscipline simulation

Many organizations use multiple, disconnected analysis tools to cover the variety of analysis needs for product development. However, using multiple tools adds costs and complexity because each analysis product has its own user interface and workflows. In addition, incompatible models and manual file transfers consume time and create errors, which sometimes hinder the multidiscipline studies necessary to correctly understand product performance.

NX Advanced Simulation is a modern simulation environment that can be extended to support solutions for more advanced structural, durability, thermal, flow, and multiphysics analyses, and the modules shown in the table below are available as add-ons to the NX Advanced Simulation environment:

Analysis type

Available add-on modules for NX Advanced Simulation

Durability	NX Durability Wizard NX Advanced Durability
Dynamic response	NX Response Simulation
Laminate composites modeling Laminate composites draping	NX Laminate Composites
Thermal Analysis	NX Thermal NX Advanced Thermal NX Space Systems Thermal NX Thermal/Flow DMP
CFD or flow analysis	NX Advanced Fluid Modeling NX Flow NX Advanced Flow NX Thermal/Flow DMP
Multiphysics	
Coupled thermo-fluid analysis	NX Electronic Systems Cooling NX Flow, NX Advanced Flow with NX Thermal, NX Advanced Thermal
Coupled thermoelastic analysis	NX Thermal with NX Advanced Simulation
Motion-structural analysis (motion with flexible bodies)	NX Motion and NX Motion Flexible Body with NX Advanced Simulation
Physical test to analysis correlation	NX FE Model Correlation NX FE Model Updating

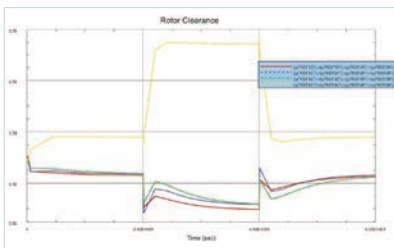
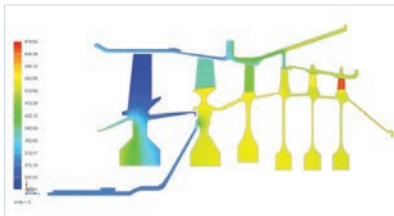
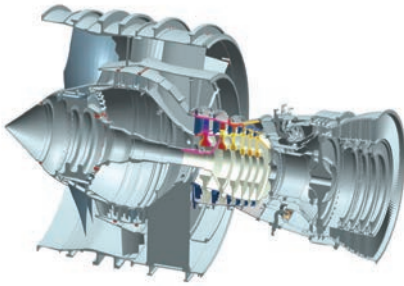

The multiphysics environment streamlines bidirectional thermal-structural coupling to study blade clearance in an aircraft engine.

Accelerating multiphysics analysis

In addition to being a platform for multidiscipline simulation, NX Advanced Simulation includes a multiphysics environment to help you connect two or more solvers to streamline the process of performing complex, multiphysics simulation. This environment delivers a consistent look and feel for performing multiphysics simulations so you can easily build coupled solutions on the same mesh using common element types, properties, boundary conditions, as well as solver controls and options.

This initial release of the multiphysics environment provides the ability to solve thermo-mechanical problems in loosely (one-way) or tightly-coupled (two-way) modes. Coupled thermal-structural analysis enables you to leverage the new NX Nastran® SOL 401 multi-step nonlinear solver and a thermal solution from the NX Thermal solver.

Using NX Advanced Simulation, you can more easily tackle complex simulations, such as blade clearance analysis within aircraft engine systems, or structural analysis of automotive powertrain components within high temperature environments. Other applications for electronic components and metalworking processes are also well suited for the multiphysics environment.

Optimizing geometry to drive design

By leveraging the powerful geometry engine within NX Advanced Simulation, you have access to a large number of geometry parameters that can be used to drive optimization processes. Design variables can include feature and sketch dimensions, expressions as well as some FE parameters, such as section properties for one-dimensional elements, and shell properties for two-dimensional elements. However, geometry optimization is not restricted to designs built in NX. You can

import geometry from other applications and define geometry design variables using synchronous technology.

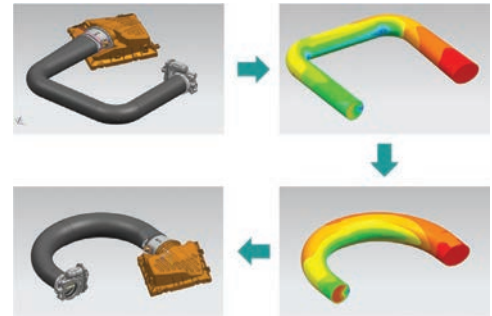

Drive design through simulation-based geometry optimization.

Managing simulation data for the analyst

NX Advanced Simulation seamlessly integrates with the entire Teamcenter® software data management portfolio, including the simulation process management module. Simulation data management capabilities work out-of-the-box, and companies can implement a complete environment for managing CAE data, processes and workflows as part of a wider product development environment. This reduces waste by promoting re-use of existing designs and engineering knowledge. It also synchronizes data and makes it readily accessible through data mining, visualization and reporting.

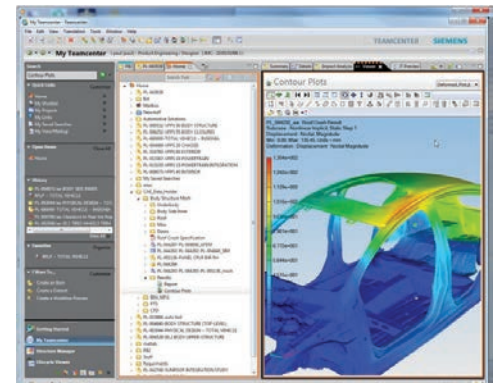

NX Advanced Simulation seamlessly integrates with Teamcenter Simulation Process Management.

Capturing knowledge and automating processes

NX Advanced Simulation allows engineering organizations to capture the expertise of senior analysts and make it available for others in the organization to use in the form of wizards or templates. CAE processes can be captured and automated using NX Open, an open framework for automation and programming. Analysts can capture the steps in a CAE process using journaling, and then develop scripts and easy-to-use dialog boxes so others can use the same process. Since NX Advanced Simulation is built on top of the same platform as NX CAD, designers who use NX continue to work in a familiar environment when they perform CAE work.

Leveraging a scalable and open simulation platform

Siemens PLM Software understands you often need to use other software tools, either developed internally or from other vendors, to get the answers you need to support critical development decisions. That's why NX Advanced Simulation is open and flexible enough to allow you to incorporate those tools into your simulation processes. NX Advanced Simulation supports a number of commercial CAE solvers through available environments, or you can develop your own interfaces using NX Open.

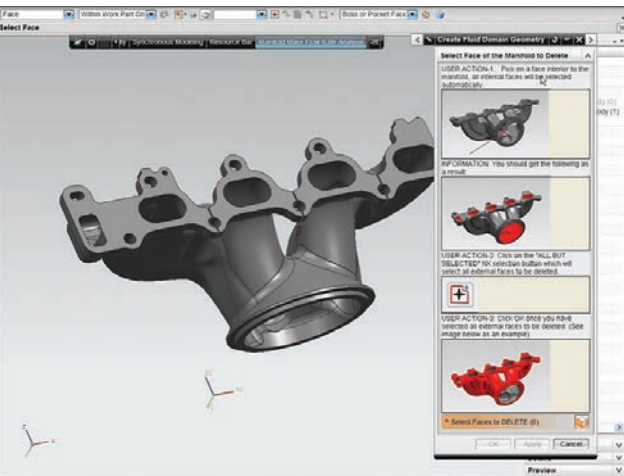

Capture and automate simulation processes using NX Open.

Contact
 Siemens PLM Software
 Americas +1 314 264 8499
 Europe +44 (0) 1276 413200
 Asia-Pacific +852 2230 3308

www.siemens.com/plm

© 2014 Siemens Product Lifecycle Management Software Inc. Siemens and the Siemens logo are registered trademarks of Siemens AG. D-Cubed, Femap, Fibersim, Geolus, GO PLM, I-deas, JT, NX, Parasolid, Solid Edge, Syncrofit, Teamcenter and Tecnomatix are trademarks or registered trademarks of Siemens Product Lifecycle Management Software Inc. or its subsidiaries in the United States and in other countries. Nastran is a registered trademark of the National Aeronautics and Space Administration. All other logos, trademarks, registered trademarks or service marks belong to their respective holders.
 8139-Y9 12/14 C